

hoop

clever little helper
User Guide

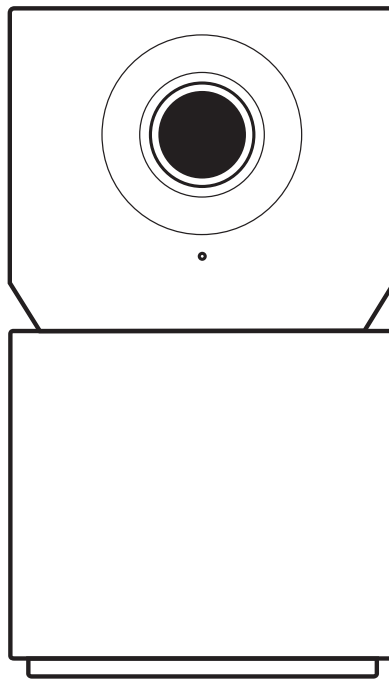

CONTENTS

| | | |
|----------|--------|-----------|
| English | •————— | 2 |
| Francais | •————— | 9 |
| Italiano | •————— | 16 |
| Espanol | •————— | 23 |
| Deutsch | •————— | 30 |

WHAT'S IN THE BOX?

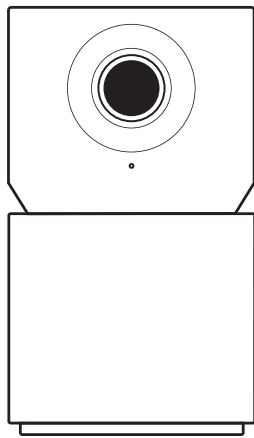

Hoop Camera (1)

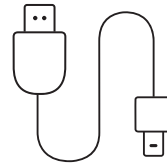

Micro USB
Power Cable (1)

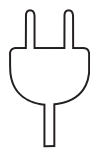

Wall
Adapter (1)

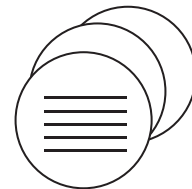

Quick Start
Guide (1)

OVERVIEW

Front View

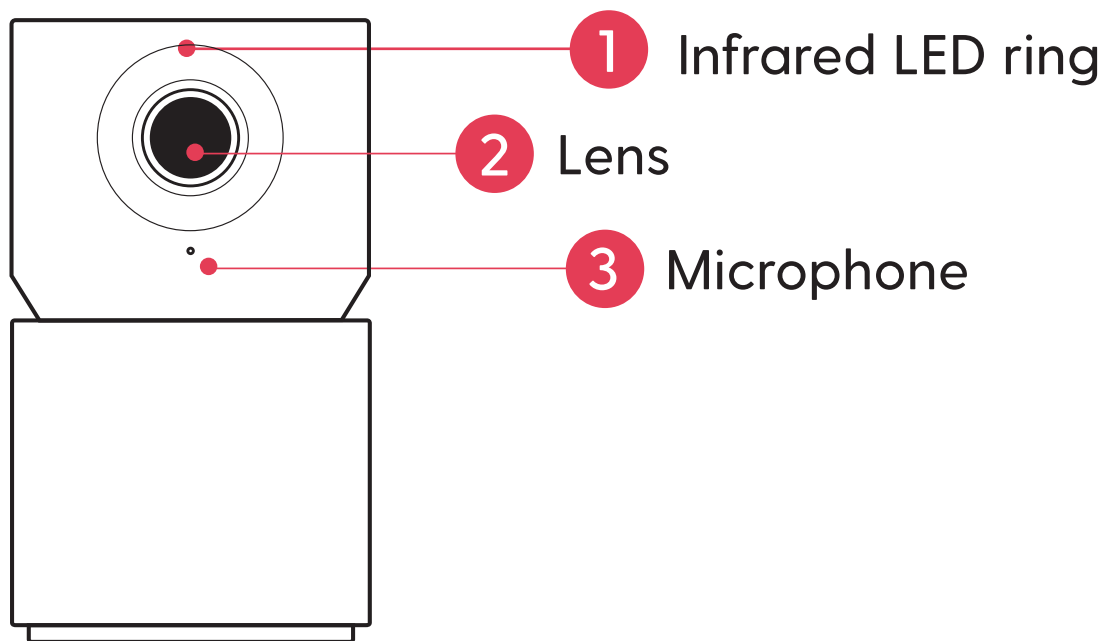

Rear View

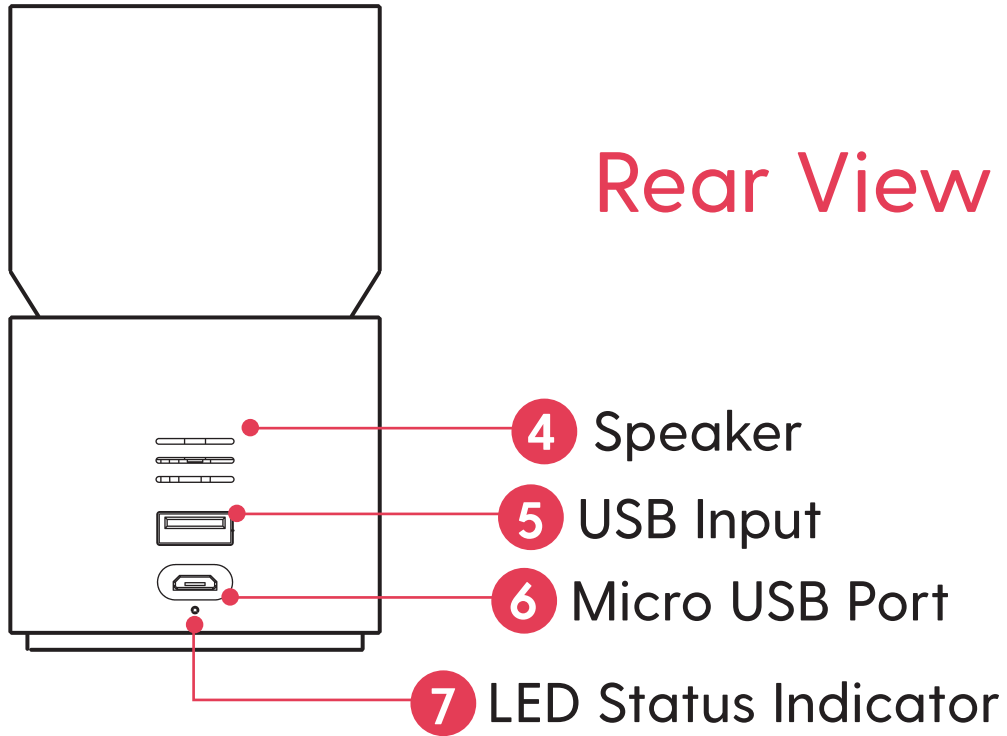

Bottom View

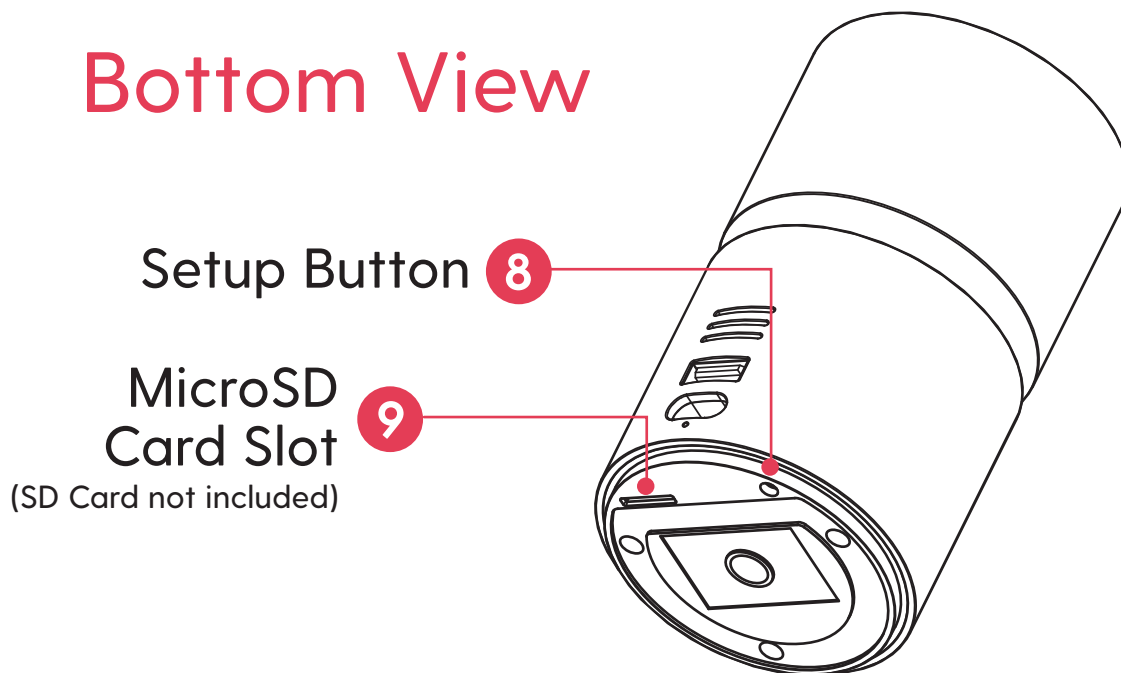

INITIAL SETUP

1

Download the **myhoophome** application and create your profile.



2

Plug the power cable into the camera and the wall adapter.
Wait 30s for the camera to perform a self-check.
The LED indicator will flash yellow.

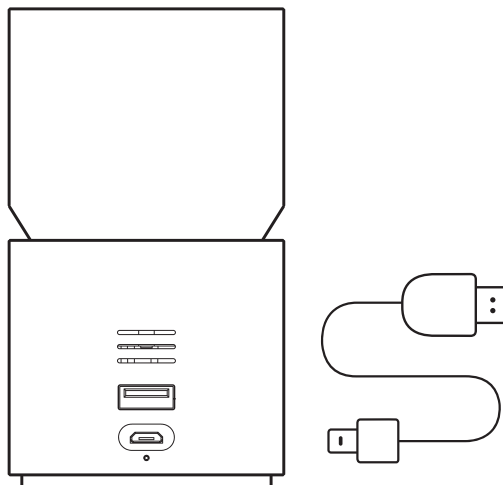

3

Press and hold the setup button until you hear a voice prompt.

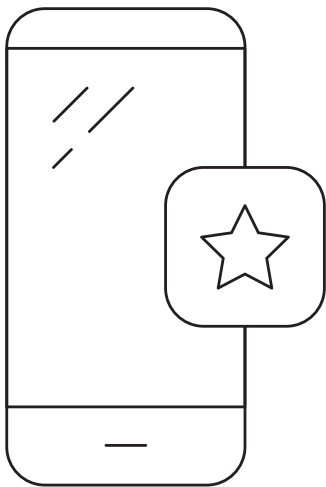
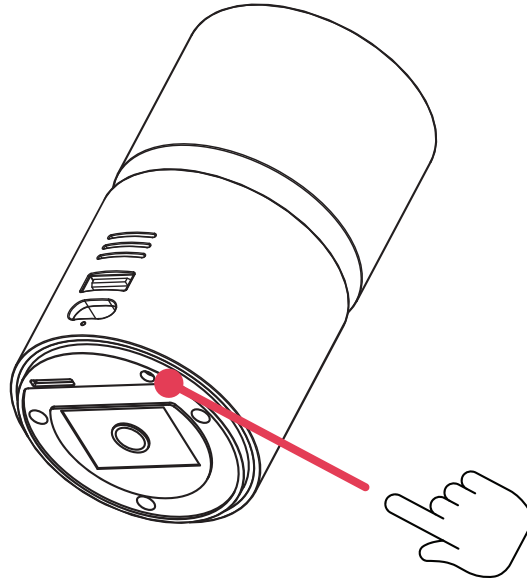

4

Open the **myhoophome** application and select 'Add a New Camera'. Follow the prompts to complete the setup process.

LED INDICATOR KEY

Yellow (solid) Powered on, starting up

Yellow (flashing) Self-check completed, ready to connect

Yellow & Blue (flashing) Connecting to application

Blue (flashing) Connected, finishing setup process

Blue (solid) Setup complete, operating normally

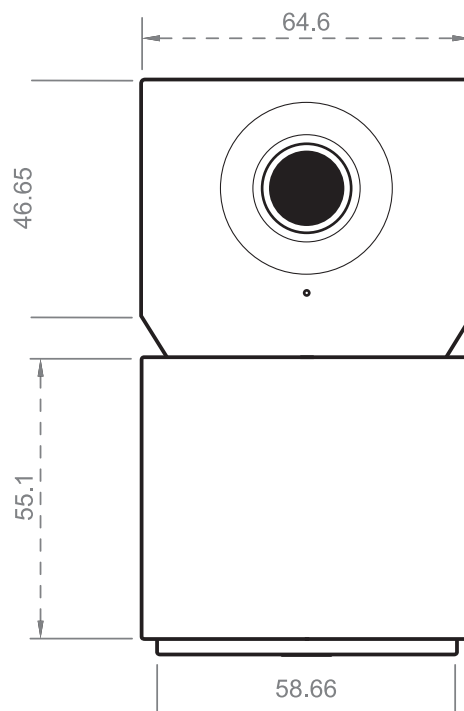

8
EN

MORE INFO



Visit us at
www.hoophome.com

follow us



FAQS: www.hoophome.com/faq
Forums: www.hoophome.com/community

Contact Us

 833-248-HOOP (4667)
 support@myhoophome.com



Hoop is a trademark of C&A IP Holdings, LLC in the U.S. All other products, brand names, company names, and logos are trademarks of their respective owners, used merely to identify their respective products, and are not meant to connote any sponsorship, endorsement, or approval.

Distributed by: C&A Marketing, Inc., 114 Tived Lane East, Edison, NJ 08837, USA
C&A Marketing UK LTD, 167 Hermitage Road, Crusader Industrial Estate, London N4 1LZ, UK ©2019.
All Rights Reserved. Made in CHINA

FCC Warning:

Any Changes or modifications not expressly approved by the party responsible for compliance could void the user's authority to operate the equipment. This device complies with part 15 of the FCC Rules. Operation is subject to the following two conditions: (1) This device may not cause harmful interference, and (2) this device must accept any interference received, including interference that may cause undesired operation.

FCC Radiation Exposure Statement:

This equipment complies with FCC radiation exposure limits set forth for an uncontrolled environment. This equipment should be installed and operated with minimum distance 20cm between the radiator & your body. This transmitter must not be co-located or operating in conjunction with any other antenna or transmitter.

Google Play Store is a trademark of Google, LLC.
Apple and App Store are trademarks of Apple Inc.
in the U.S. and other countries.
MicroSD is a trademark of SD-3C, LLC.



CONTENU DE LA BOÎTE?

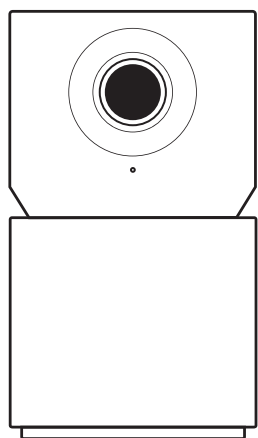

Caméra Hoop (1)

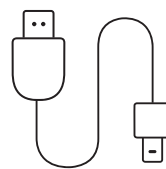

Câble d'alimentation
micro USB (1)

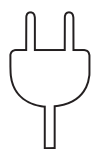

Adaptateur
secteur (1)

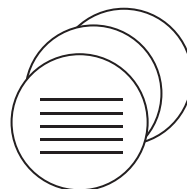

Guide de
démarrage rapide (1)

VUE D'ENSEMBLE

Vue avant

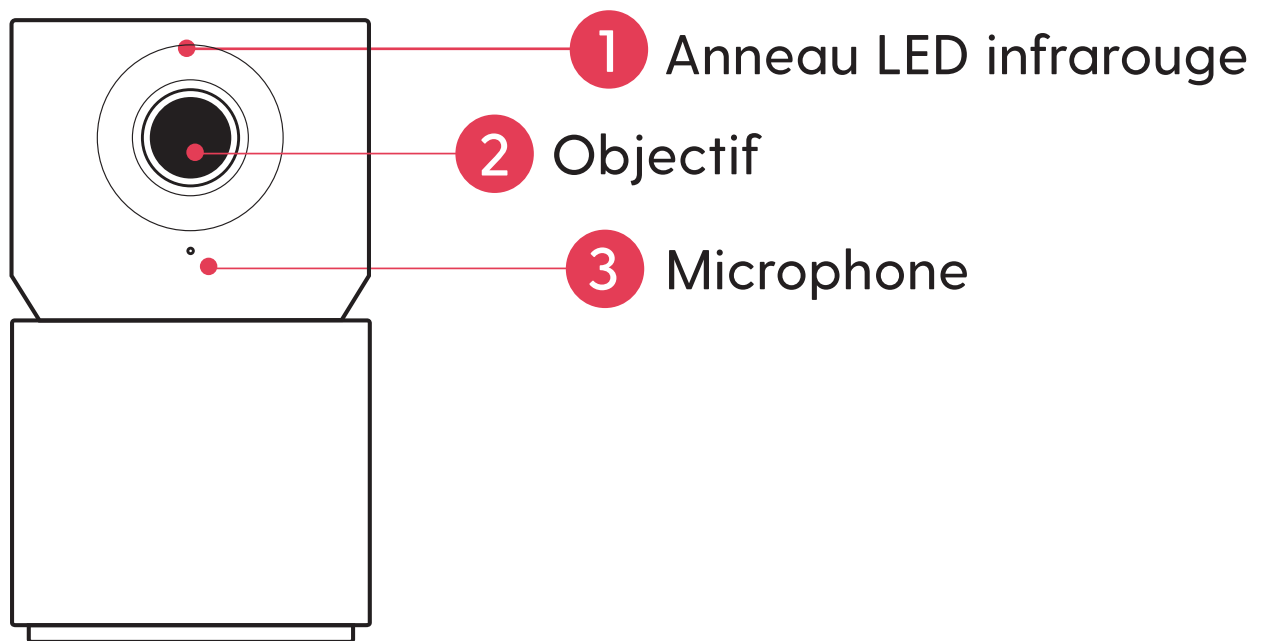

Vue arrière

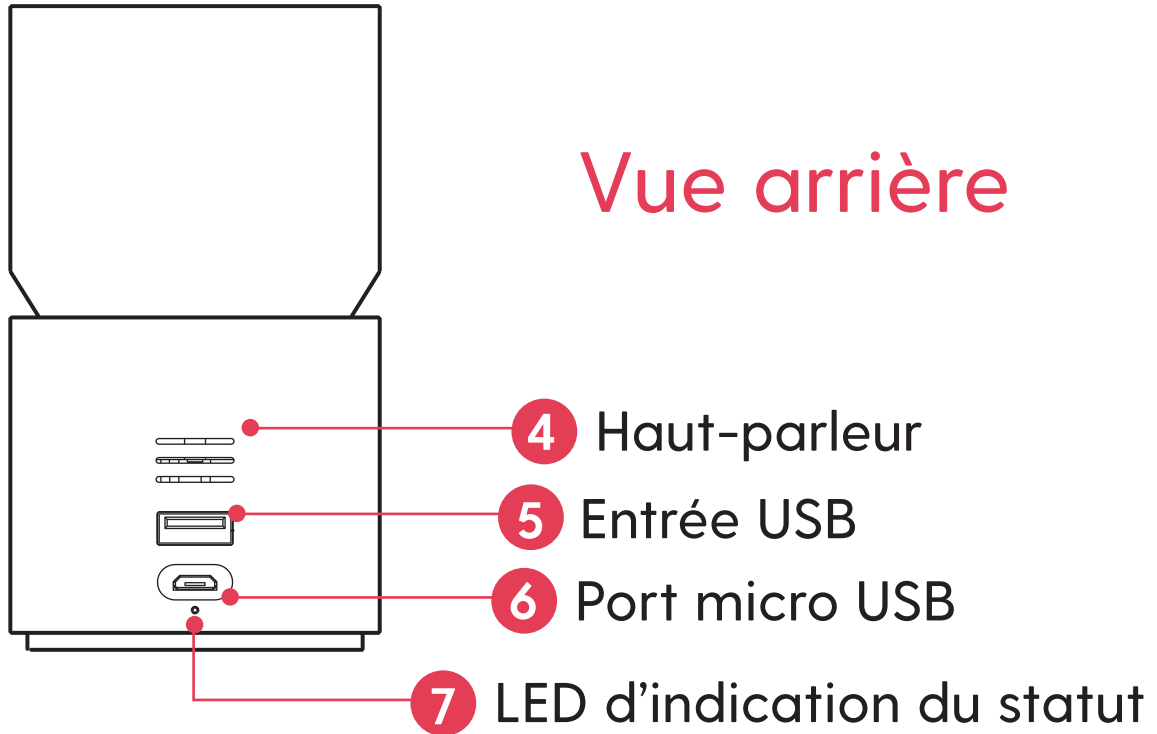

Vue de dessous

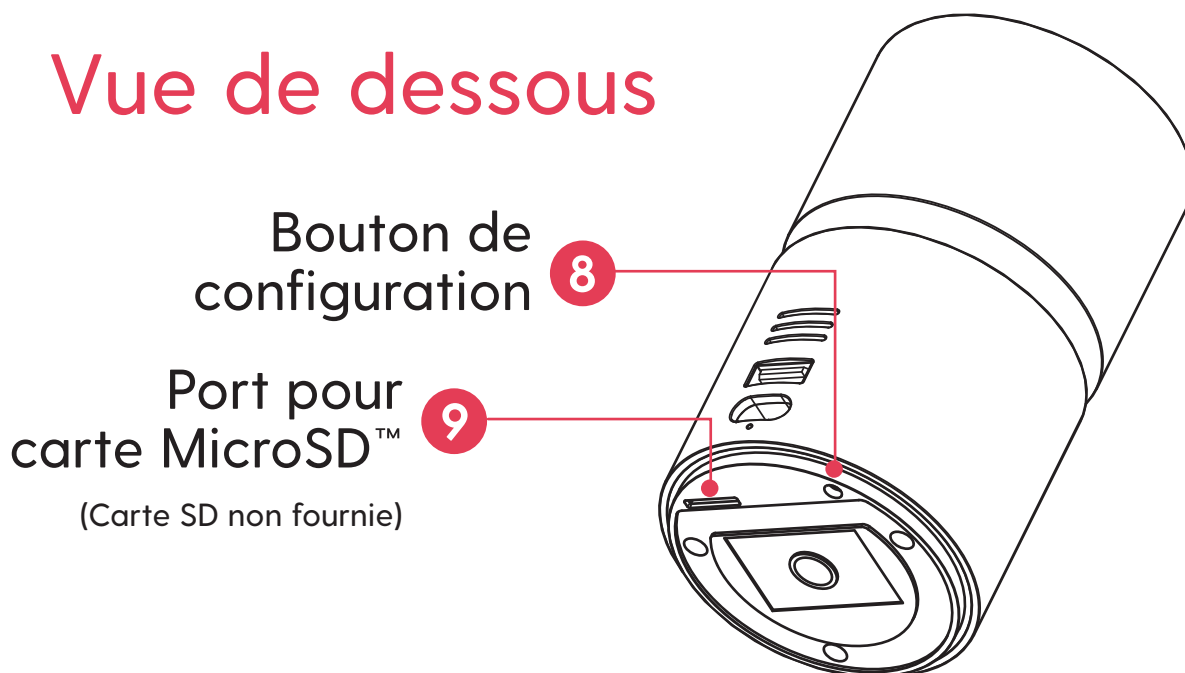

CONFIGURATION INITIALE

1

Téléchargez l'application **myhoophome** et créez votre profil.



2

Branchez le câble d'alimentation sur la caméra et l'adaptateur secteur.
Patientez 30 sec. environ, pendant que la caméra effectue un autocontrôle.
L'indicateur LED clignotera en jaune.

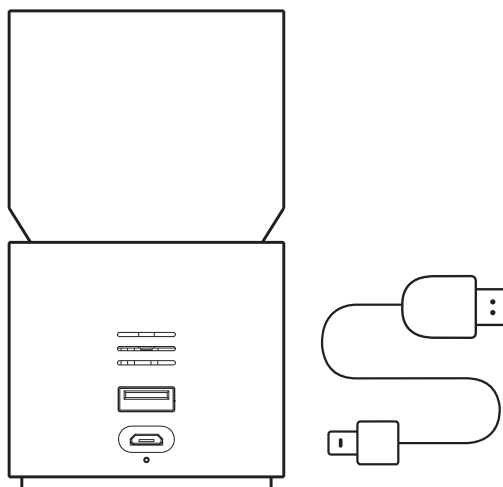

3

Maintenez l'appui sur bouton de configuration jusqu'à l'invite vocale.

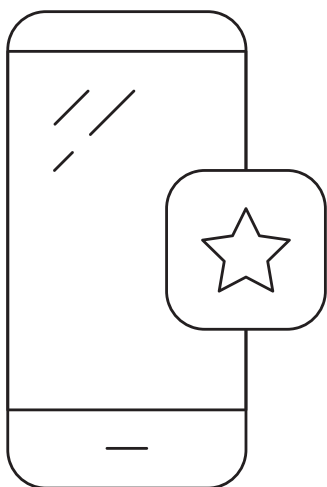
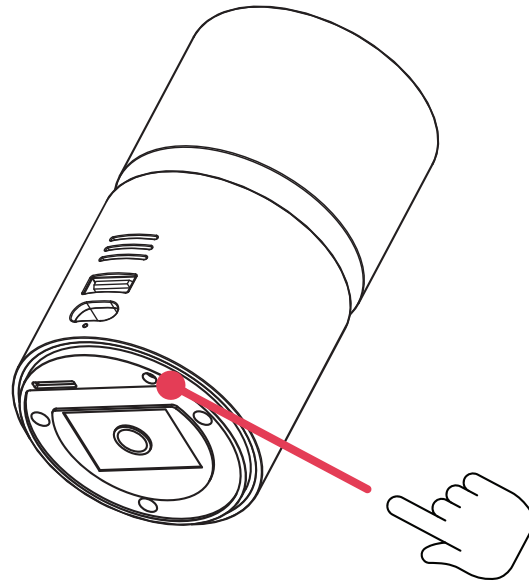

4

Ouvrez l'application **myhoophome** et sélectionnez 'Ajouter une nouvelle caméra'. Suivez les instructions pour terminer la configuration.

SIGNIFICATION DE L'INDICATEUR LED

Jaune (fixe) Caméra sous tension, en cours de démarrage

Jaune (clignotant) Autocontrôle terminé, caméra prête pour la connexion

Jaune et bleu (clignotant) Connexion à l'application

Bleu (clignotant) Caméra connectée, finalisation de la configuration

Bleu (fixe) Configuration terminée, fonctionnement normal

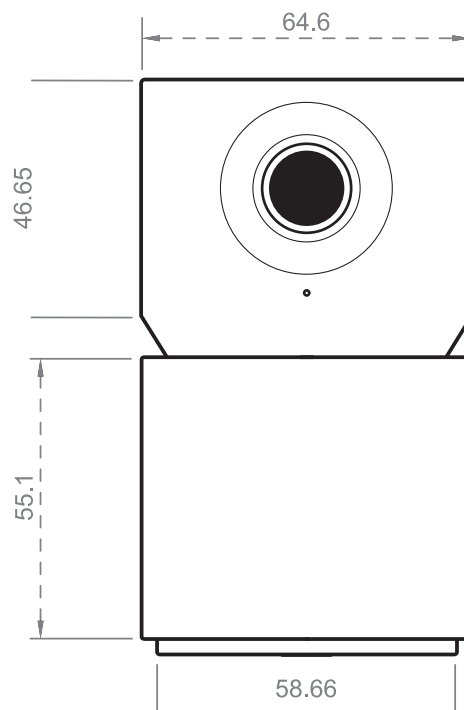

15
FR

PLUS D'INFORMATIONS

Consultez
www.hoophome.com

suivez-nous



FAQS: www.hoophome.com/faq

Forums: www.hoophome.com/community

Nous contacter

 833-248-HOOP (4667)

 support@myhoophome.com



Hoop est une marque déposée de C&A IP Holdings, LLC aux États-Unis. Tous les autres produits, noms commerciaux, noms de sociétés et logos sont des marques déposées de leurs propriétaires respectifs, utilisées uniquement à des fins d'identification de leurs produits respectifs, et ne suggèrent en aucun cas un parrainage, un soutien ou une approbation.

Distribué par : C&A Marketing, Inc., 114 Tived Lane East, Edison, NJ 08837, USA C&A Marketing UK LTD, 167 Hermitage Road, Crusader Industrial Estate, London N4 1LZ, UK ©2019. Tous droits réservés. Fabriqué en Chine

Avertissement de la FCC:

Tout changement ou modification non approuvé expressément par l'autorité responsable de la conformité peuvent annuler l'autorisation accordée à l'utilisateur de faire fonctionner cet équipement. Ce dispositif est conforme à la section 15 du règlement de la FCC. Le fonctionnement est soumis aux conditions suivantes : (1) cet appareil ne peut causer d'interférences nuisibles, et (2) il doit accepter toute interférence reçue, notamment celles pouvant entraîner un dysfonctionnement.

Déclaration de la FCC sur l'exposition aux rayonnements:

Cet équipement est conforme aux limites de radiation de la FCC comme indiquées pour un environnement non contrôlé. Cet équipement doit être installé et utilisé en respectant une distance minimale de 20 cm avec l'utilisateur. Cet émetteur ne doit pas être installé ou utilisé conjointement avec d'autres antennes ou autres émetteurs.

Google Play Store est une marque déposée de Google, LLC. Apple et App Store sont des marques déposées d'Apple Inc. aux États-Unis et dans d'autres pays. MicroSD est une marque déposée de SD-3C, LLC.



COSA C'È NELLA SCATOLA?

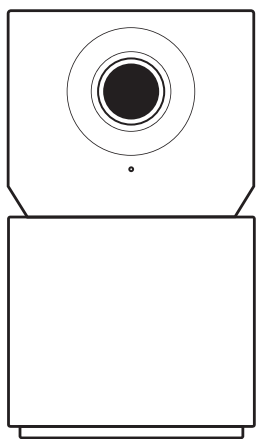

Hoop Cam (1)

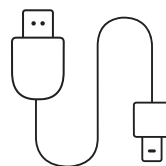

Cavo di alimentazione
micro USB (1)

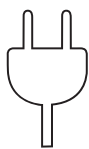

Adattatore
da parete (1)

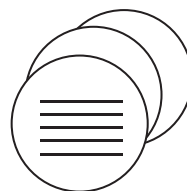

Guida
rapida (1)

RIEPILOGO

Visione anteriore

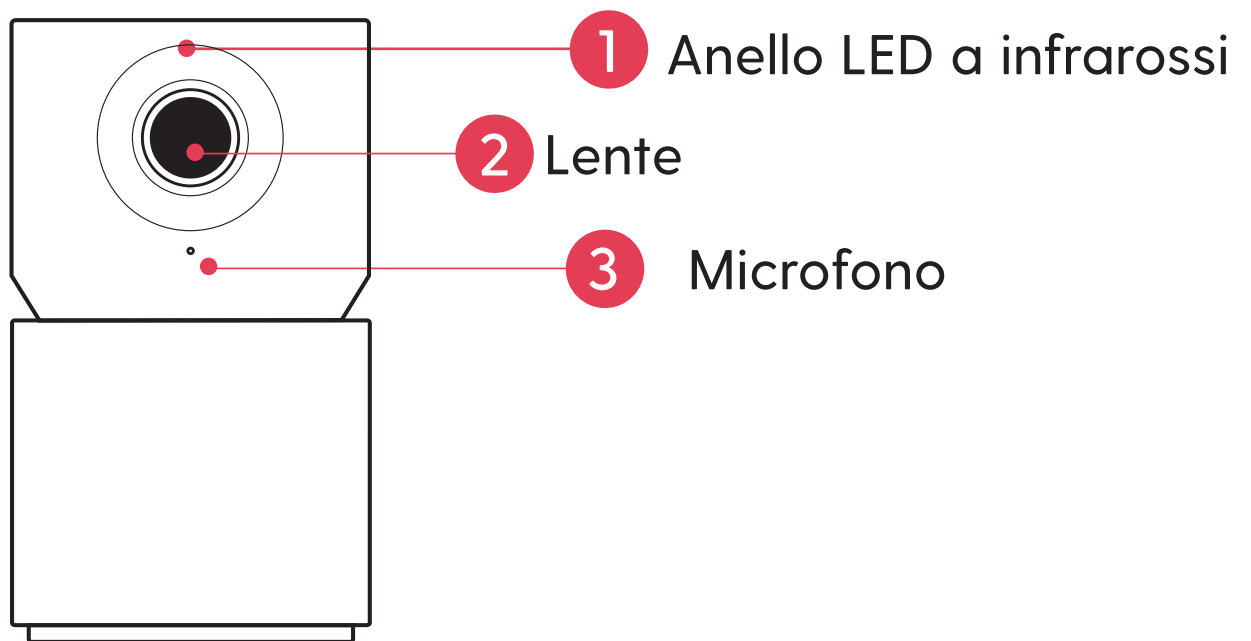

Visione posteriore

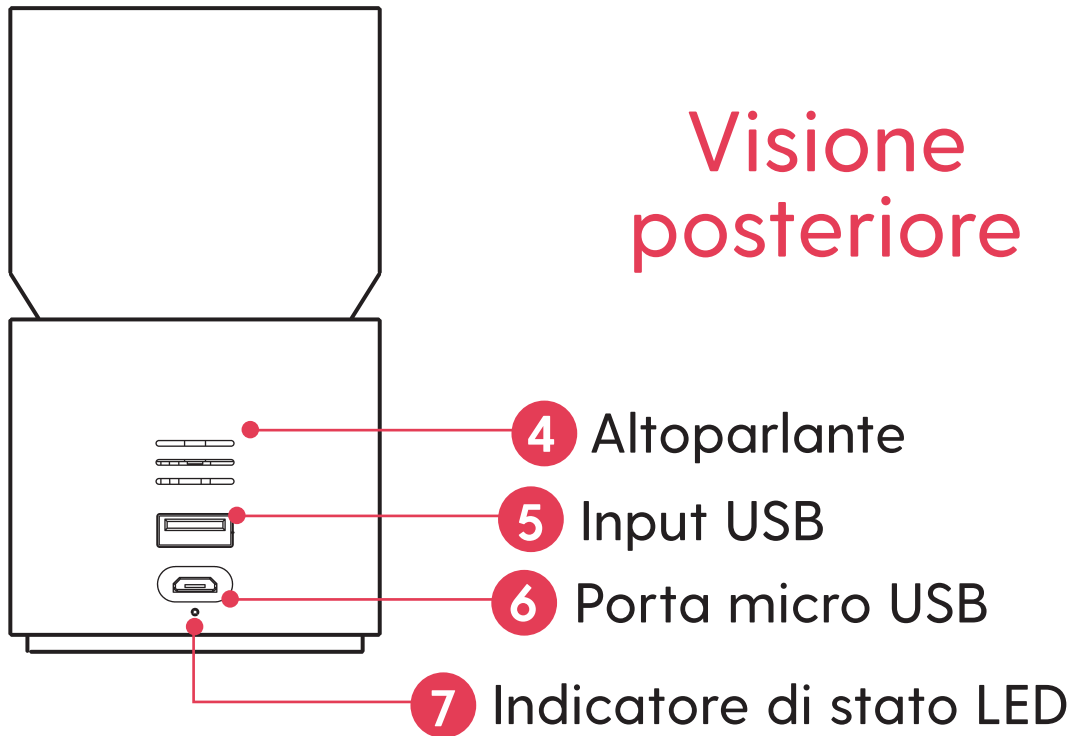

Visione dal basso



CONFIGURAZIONE INIZIALE

1

Scarica l'app **myhoophome** e crea il tuo profilo.



2

Collega il cavo di alimentazione alla telecamera e all'adattatore a parete. Aspetta circa 30 secondi per consentire alla telecamera di effettuare l'autodiagnosi. L'indicatore LED emetterà una luce gialla lampeggiante.

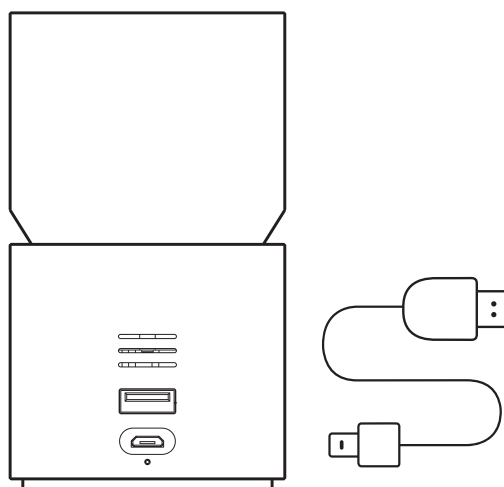

3

Premi e tieni premuto il pulsante di configurazione finché senti un comando vocale.

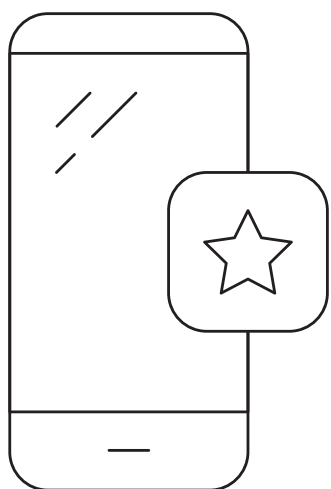
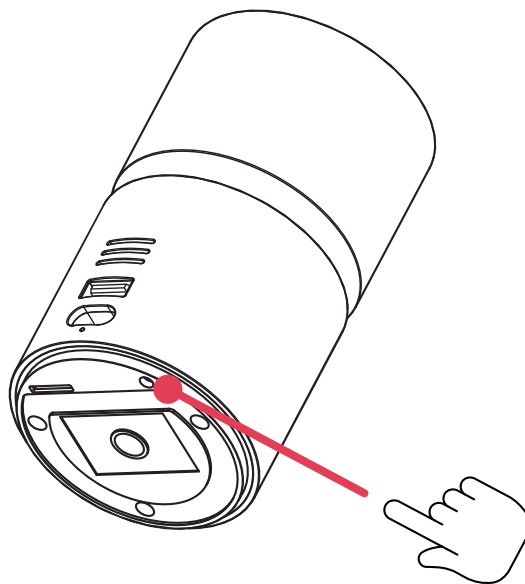

4

Apri l'applicazione **myhoophome** e seleziona "Aggiungi una nuova telecamera". Segui i comandi per completare il processo di configurazione.

LEGENDA INDICATORE LED

Luce gialla (fissa) Accesa e in avvio

Luce gialla (lampeggiante) Autodiagnosi completata, pronta a connettersi

Luce gialla e blu (lampeggiante) Connessione all'applicazione in corso

Luce blu (lampeggiante) Connessa, processo di configurazione in fase di ultimazione

Luce blu (fissa) Configurazione completata, funzionamento normale

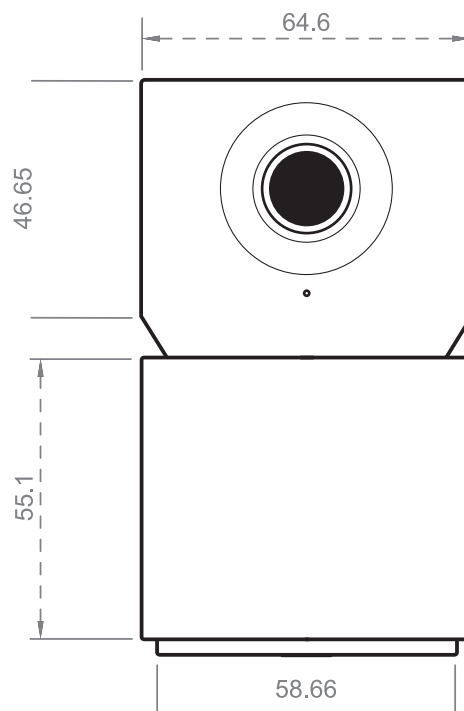

22
IT

ULTERIORI INFORMAZIONI

Vieni a trovarci su
www.hoophome.com

seguidici



DOMANDE FREQUENTI: www.hoophome.com/faq
Forums: www.hoophome.com/community

Contact Us

 833-248-HOOP (4667)

 support@myhoophome.com



Hoop è un marchio di C&A IP Holdings, LLC registrato negli Stati Uniti. Tutti gli altri prodotti, marchi, denominazioni sociali e loghi sono marchi registrati dei rispettivi titolari, utilizzati esclusivamente per identificare i rispettivi prodotti, senza implicare alcun rapporto di sponsorizzazione, avallo o approvazione.

Distribuito da: C&A Marketing, Inc., 114 Tived Lane East, Edison, NJ 08837, USA
C&A Marketing UK LTD, 167 Hermitage Road, Crusader Industrial Estate, London N4 1LZ, UK ©2019.
Tutti i diritti riservati. Prodotto in CINA

Avvertenza ai sensi della normativa FCC:

Qualunque intervento o modifica non espressamente approvato dalla parte responsabile della conformità potrebbe invalidare l'autorizzazione resa all'utente di utilizzare l'equipaggiamento. Questo dispositivo è conforme alla Parte 15 delle Regole FCC. Il suo utilizzo è soggetto alle seguenti due condizioni: (1) Il presente dispositivo non può causare interferenze dannose e (2) il presente dispositivo deve accettare qualunque interferenza riceva, comprese le interferenze suscettibili di determinare un utilizzo non desiderato.

Dichiarazione sull'esposizione alle radiazioni ai sensi della normativa FCC:

Il presente equipaggiamento è conforme ai limiti di esposizione alle radiazioni fissati dalla FCC per gli ambienti non soggetti a controllo. Il presente equipaggiamento andrebbe installato e utilizzato a una distanza minima di 20 cm fra il radiatore e il corpo. Il presente trasmettitore non deve essere collocato sullo stesso luogo o utilizzato insieme con qualunque altra antenna o trasmettitore.

Google Play Store è un marchio di Google, LLC.
Apple e Apple Store sono marchi commerciali di Apple Inc. registrati negli USA e in altri Paesi.
MicroSD è un marchio di SD-3C, LLC.



¿QUÉ CONTIENE LA CAJA?

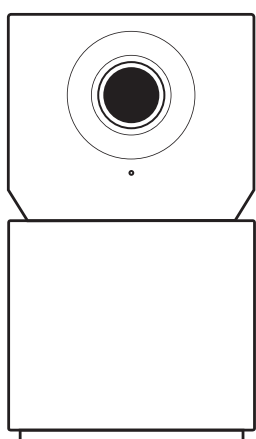

Una cámara Hoop (1)

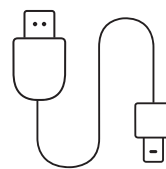

Un cable de corriente micro USB (1)

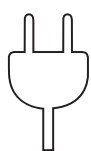

Un enchufe adaptador (1)

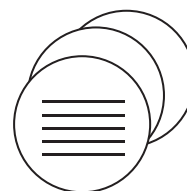

Una Guía de inicio rápido (1)

RESUMEN

Vista frontal

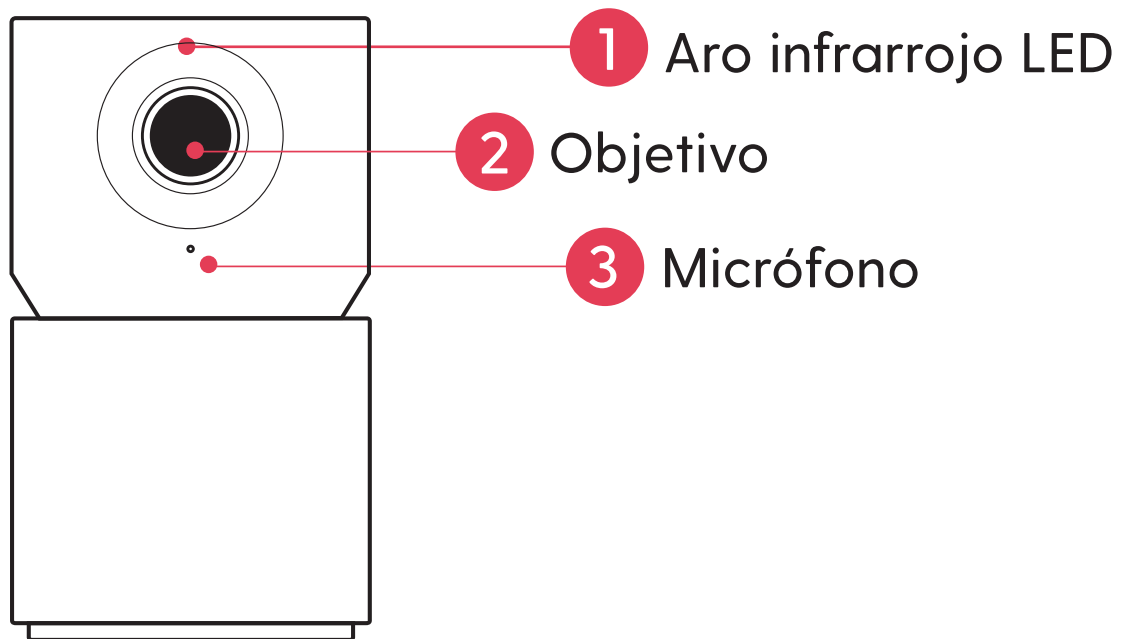

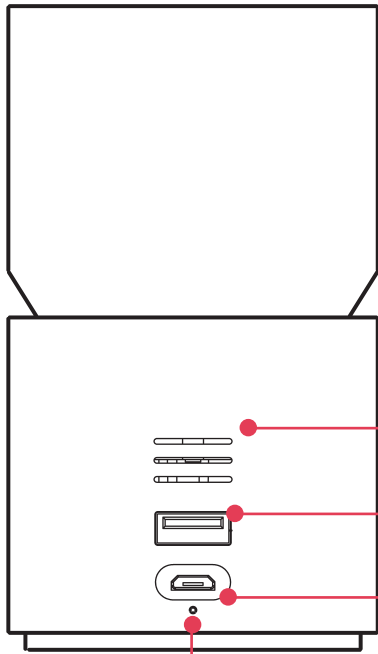

Vista trasera

- 4 Altavoz
- 5 Entrada USB
- 6 Puerto micro USB
- 7 Indicador LED del estado

Vista de abajo

- Botón de configuración 8
- Ranura para tarjeta MicroSD™
(Tarjeta SD, no incluida) 9

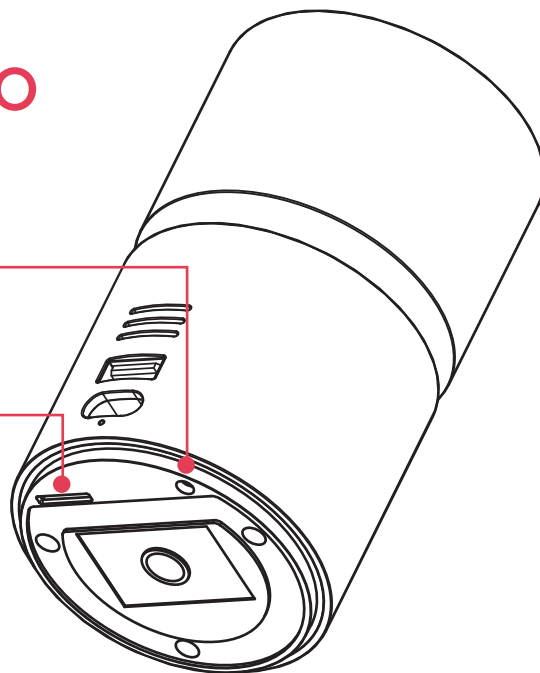

PUESTA EN MARCHA INICIAL

1

Descargue la aplicación **Myhoophome** y cree su perfil.



2

Enchufe el cable de corriente a la cámara y al enchufe adaptador. Espere ~ 30 s para que la cámara se revise. El indicador LED destellará en amarillo.

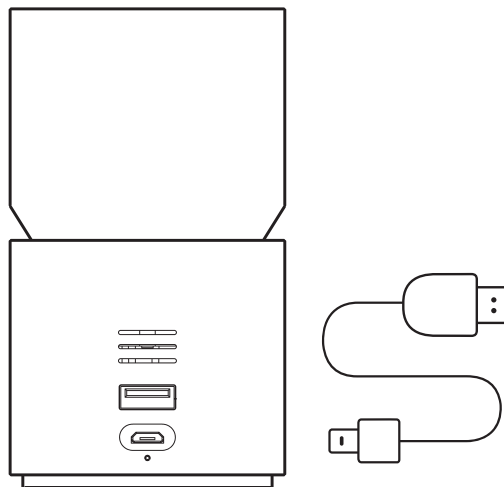

3

Apriete y sostenga el botón de configuración hasta que oiga una indicación de voz.

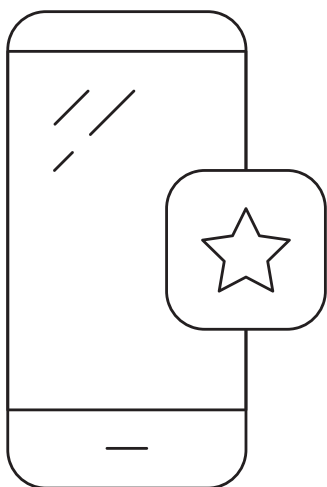
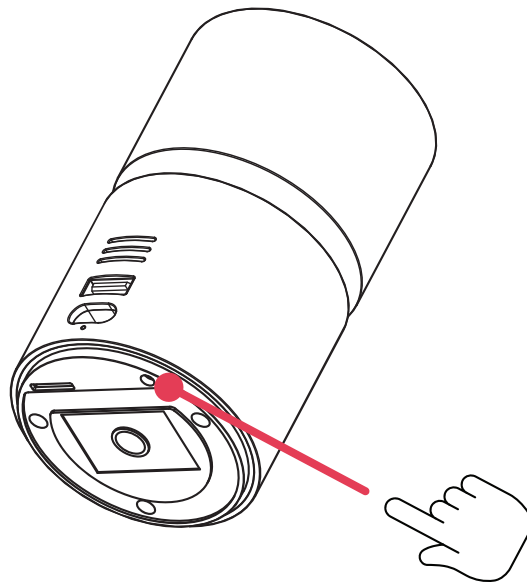

4

Abra la aplicación **Myhoophome** y seleccione 'Añadir una nueva cámara'. Siga las indicaciones para completar el proceso de la configuración.

CLAVE DEL INDICADOR LED

Amarillo (sólido) Encendido, en proceso de puesta en marcha

(Destellos) amarillos Ha terminado su revisión, lista para conectarla

(Destello) amarillo y azul Conectando con la aplicación

(Destellos) azules Conectada, terminando el proceso de configuración

Azul (sólido) Configuración terminada, en funcionamiento normal

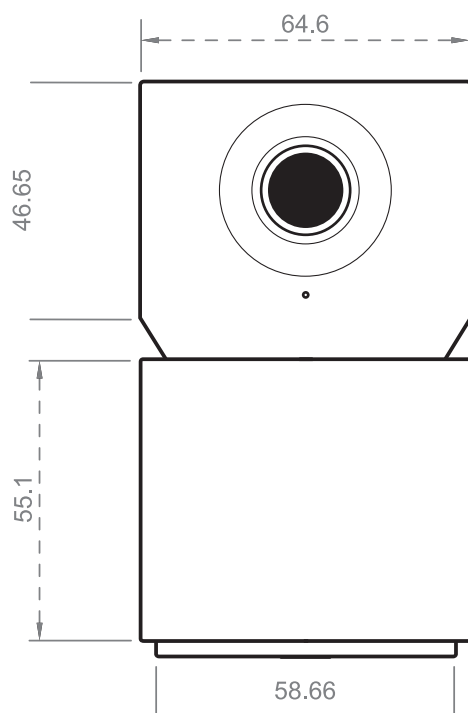

29
ES

MÁS INFORMACIÓN



Visítenos en
www.hoophome.com

síguenos



Preguntas frecuentes: www.hoophome.com/faq
Foros: www.hoophome.com/community

Contacto

 833-248-HOOP (4667)
 support@myhoophome.com



Hoop es una marca comercial de C&A IP Holdings, LLC en los Estados Unidos. Todos los otros productos, nombres de marcas, nombres de compañías y logotipos son marcas comerciales de sus respectivos propietarios, usados solo para identificar sus correspondientes productos y no pretenden indicar ningún patrocinio, respaldo o aprobación.

Distribuido por: C&A Marketing, Inc., 114 Tived Lane East, Edison, NJ 08837, Estados Unidos de América
C&A Marketing UK LTD, 167 Hermitage Road, Crusader Industrial Estate, Londres N4 1LZ, UK ©2019. Todos los derechos reservados. Fabricada en China

Advertencia de la FCC:

Cualquier cambio o modificación que no haya sido aprobada expresamente por la parte responsable del cumplimiento, podría anular el derecho del usuario a utilizar el equipo. Este dispositivo cumple con la parte 15 de las Normas de la FCC. El uso está sujeto a las dos condiciones siguientes: (1) Este dispositivo no puede causar una interferencia dañina y (2) este dispositivo debe de aceptar cualquier interferencia recibida, incluso las interferencias que puedan dar lugar a un funcionamiento no deseado.

Declaración de exposición a la radiación de la FCC:

Este equipo cumple con los límites de exposición a la radiación de la FCC establecidos para un ambiente sin control. Este equipo debe instalarse y utilizarse con una distancia mínima de 20 cm entre el radiador y su cuerpo. Este transmisor no debe colocarse o utilizarse junto con cualquier otra antena o transmisor.

Google Play Store es una marca registrada de Google, LLC.
Apple y App Store son marcas registradas de Apple Inc. en los Estados Unidos y otros países. MicroSD es una marca registrada de SD-3C, LLC.



WAS IST IN DER VERPACKUNG?

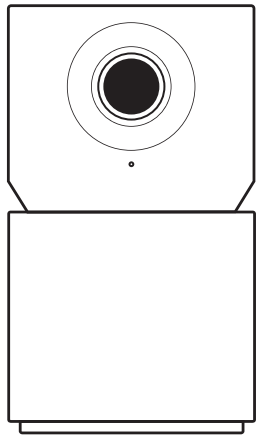

Hoop-Kamera (1)

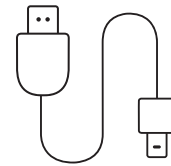

Mikro-USB-
Stromkabel (1)

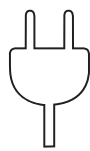

Steckernetzteil (1)

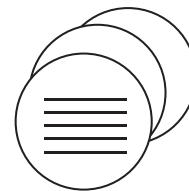

Kurzanleitung zur
Erstverwendung (1)

ÜBERBLICK

Vorderansicht

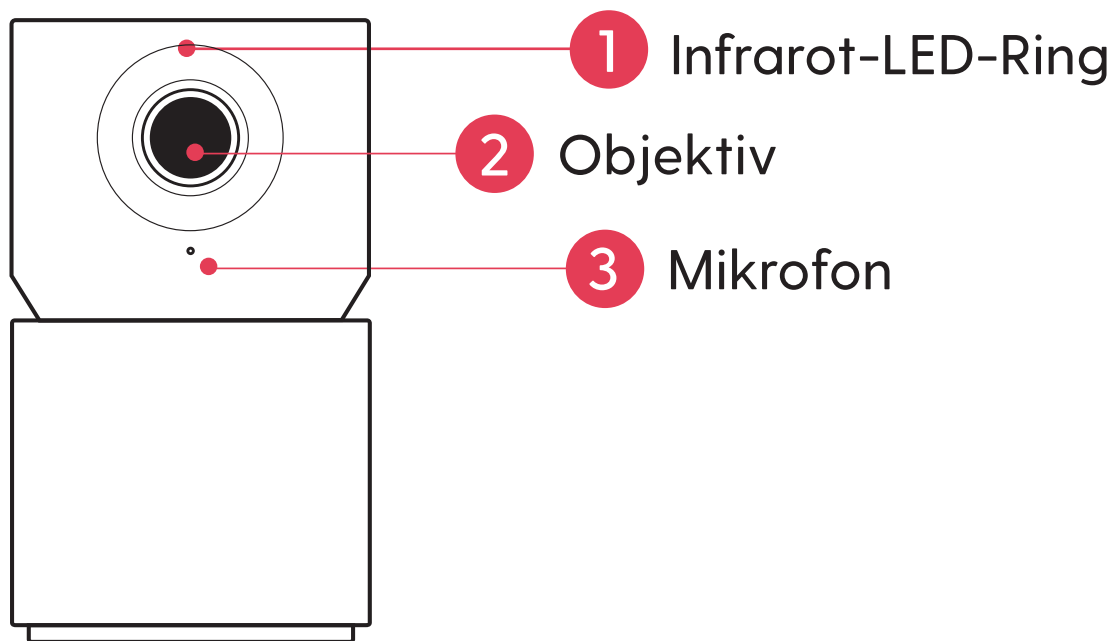

Rückansicht

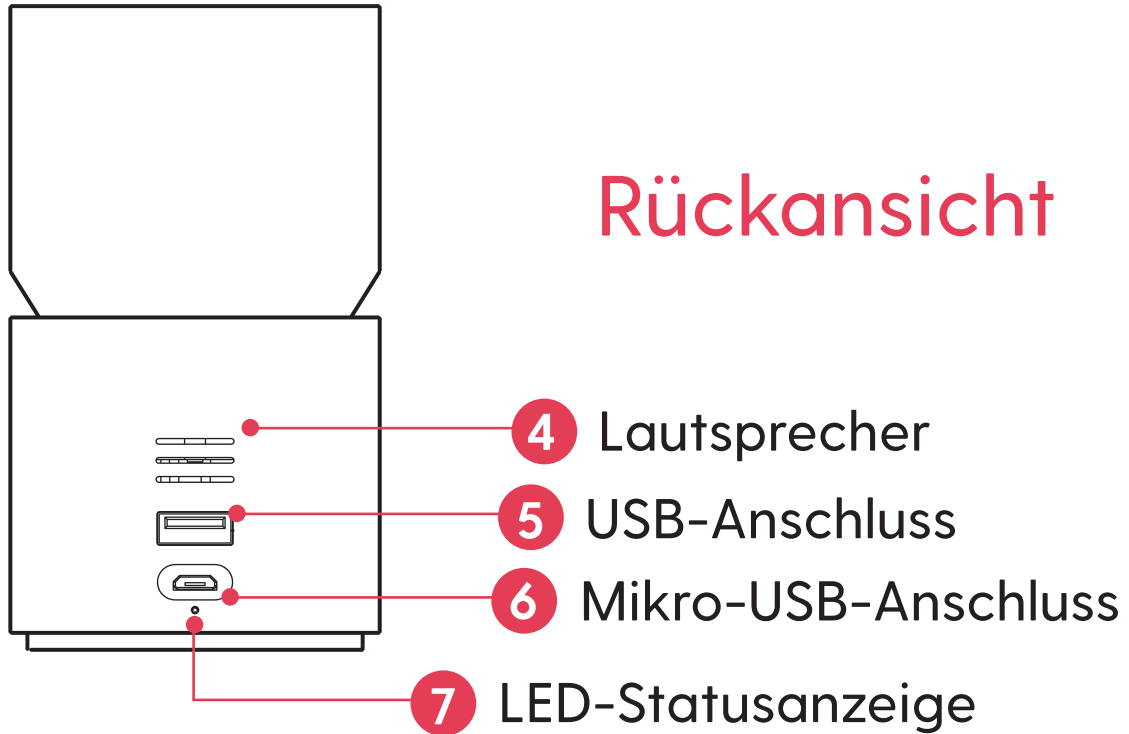

Unterseitenansicht



ERSTINSTALLATION

1

Laden Sie die **Myhoophome**-Anwendung herunter und erstellen Sie Ihr Profil.



2

Stecken Sie das Stromkabel in die Kamera und das Steckernetzteil. Warten Sie ~30 Sek., bis die Kamera eine Eigenkontrolle vorgenommen hat. Die LED-Anzeige leuchtet gelb auf.

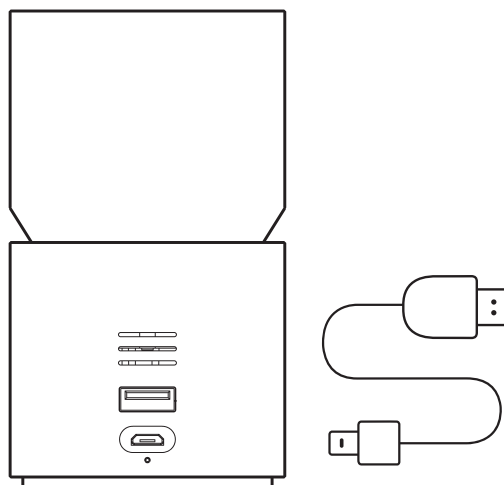

3

Drücken Sie den Installationsknopf solange, bis Sie eine Sprachansage hören.

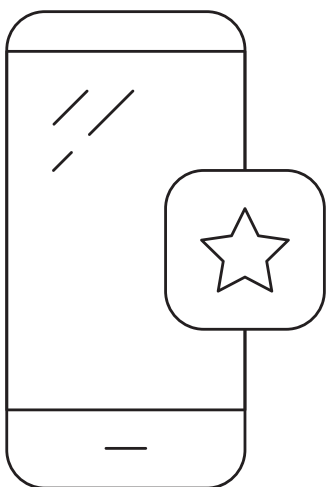
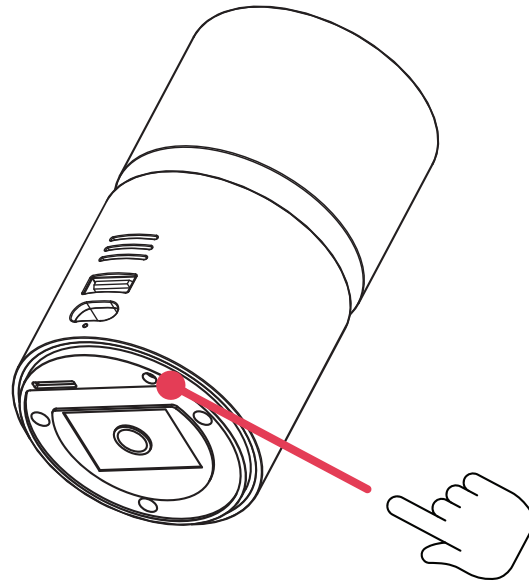

4

Öffnen Sie die **Myhoophome**-Anwendung und wählen Sie ‚Eine neue Kamera hinzufügen‘. Befolgen Sie die Ansagen, um das Installationsverfahren abzuschließen.

35
DE

LED-ANZEIGENSCHLÜSSEL

Gelb (permanent) In Betrieb, schaltet sich ein

Gelb (blinkend) Eigenkontrolle beendet. Bereit zum Verbinden

Gelb und Blau (blinkend) Verbindung zur Anwendung wird hergestellt

Blau (blinkend) Verbunden. Installationsverfahren wird abgeschlossen

Blau (permanent) Installation ist abgeschlossen. Normalbetrieb

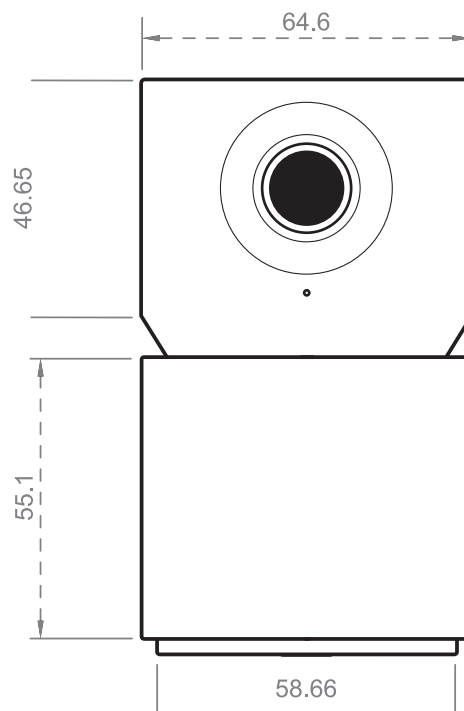

36
DE

WEITERE INFOS

Besuchen Sie uns auf
www.hoophome.com

folgen Sie uns



FAQs: www.hoophome.com/faq
Foren: www.hoophome.com/community

Kontaktieren Sie uns
☎ **833-248-HOOP (4667)**
✉ support@myhoophome.com



Hoop ist eine Handelsmarke von C&A IP Holdings, LLC in den U.S.A. Alle anderen Produkte, Handels- sowie Firmennamen und Logos sind Marken ihrer jeweiligen Besitzer, die allein zur Bezeichnung der entsprechenden Produkte verwendet werden. Sie sind nicht dazu bestimmt, einer Sponsorenschaft, Billigung oder Zustimmung zum Ausdruck zu bringen.

Vertrieben von: C&A Marketing, Inc., 114 Tived Lane East, Edison, NJ 08837, USA C&A Marketing UK LTD, 167 Hermitage Road, Crusader Industrial Estate, London N4 1LZ, UK ©2019. Alle Rechte vorbehalten. Hergestellt in CHINA reservados. Fabricada en China

AFCC-Warnung:

Jegliche Änderungen oder Abwandlungen, die nicht ausdrücklich von der für die Compliance verantwortliche Partei genehmigt wurden, kann die Berechtigung des Benutzers zum Betrieb des Geräts möglicherweise aufheben. Dieses Gerät entspricht Teil 15 der FCC-Vorschriften. Der Betrieb unterliegt den beiden folgenden Bedingungen: (1) Dieses Gerät darf keine schädlichen Störungen verursachen und (2) dieses Gerät muss jede empfangene Störung annehmen einschließlich solcher, die zu unerwünschten betrieblichen Vorkommnissen führen können.

FCC Strahlenschutzzerklärung:

Diese Ausrüstung entspricht den von der FCC für eine unkontrollierte Umgebung festgelegten Strahlungsschutzgrenzen. Sie sollte mit einem Mindestabstand von 20 cm zwischen der Strahlungsquelle und Ihrem Körper installiert und betrieben werden. Der Transmitter darf nicht zusammen mit einer anderen Antenne oder einem anderen Sender aufgestellt oder betrieben werden.

Google Play Store ist eine Marke von Google, LLC.
Apple und App Store sind Marken von Apple Inc.
in den USA und anderen Ländern.
MicroSD ist eine Marke von SD-3C, LLC.



hoop